

MTS High-Force Servohydraulic Test Systems

Delivering a full spectrum of high-force testing capabilities

be certain.

Meet a full spectrum of high-force testing requirements

High-force mechanical testing is critical for determining the performance and durability properties of large, high-strength materials, components and sub-assemblies across a diverse array of industries. Procuring equipment to fulfill this need, however, can be challenging as required test applications can range widely from simple, static strength characterization to complex, dynamic life studies.

To meet this challenge, MTS offers a family of versatile servohydraulic test systems designed to deliver a full spectrum of static and dynamic high-force testing capabilities, from simple strength testing, through dynamic characterization of structures, to comprehensive fracture and fatigue testing. More than three-hundred MTS High-force Test Systems are deployed worldwide, performing these mechanical tests within industries such as civil engineering, aerospace, rail, ground vehicles and more, on a wide range of specimens, including:

- » Metal components such as sheet, plate or bar, structural steel, welds, wire, cable, chain, and castings or forgings
- » Civil structures and substructures such as beams, columns, rebar, bearings and fasteners, and construction materials such as composites or reinforced concrete
- » Geomaterials
- » Aerospace components and sub-structures
- » Oil and gas pipeline components
- » Rail structures and components
- » Wind turbine structures and components

Uniquely suited for the tremendous demands of high-force, high-velocity tension and compression, and high-frequency fatigue testing, the MTS high-force system family features an array of standard, high-stiffness Model 311 load frames, a broad offering of performance-driven hydraulics packages, advanced controls and application software, a full complement of accessories, and numerous optional features and capabilities.

Additionally, many aspects of MTS high-force test systems, including load frame geometry, servocontrols and hydraulic distribution systems, can be

custom engineered to meet even the most extreme high-force materials, component or sub-assembly testing needs.

MTS high-force test systems are backed by the global MTS Service & Support organization, a highly experienced team committed to maintaining the uptime and operational efficiency of your test system investment.

Contact MTS today and explore how versatile MTS test systems can help you meet a full spectrum of high-force materials, component and subassembly testing needs.

3



Photo courtesy of JAXA
(Japan Aerospace Exploration Agency)

A comprehensive portfolio of high-force load frames

The MTS high-force system family features a complete array of ultra-stiff, four-column standard servohydraulic load frames, dynamically rated to deliver loads ranging from 1 to 5 MN. Higher capacity load frames and unique features can be custom engineered to order. Truly dynamic, high-stiffness designs ensure optimal high-force specimen loading and continuous over-center reliability in tension-compression cycling. MTS servovalves and force transducers provide precision, closed-loop accuracy. Model 311 load frames exhibit superior system alignment, which minimizes bending strain to enhance test accuracy and reduce data scatter. Additionally, crosshead-mounted actuators and hydraulic crosshead lift and lock mechanisms serve to simplify test setup, reduce fixturing costs and help facilitate safe operation.

Optional load frame features and capabilities include:

- » Larger force capacities up to and exceeding 30 MN
- » Longer actuator stroke lengths
- » Larger test space geometries
- » Choice of free-standing, self-reacting load frame or integrated strong floor base configurations
- » Automated crosshead lift/locks and controls – free-standing or hose stand-mounted
- » Extended baseplates to accommodate large bending tests or an additional actuator for biaxial specimen loading

VERSATILE MTS HIGH-FORCE SYSTEMS ARE USEFUL FOR CONDUCTING THESE TESTS

- » High-cycle fatigue
- » Low-cycle fatigue
- » Fatigue crack growth
- » Fracture toughness
- » Crack propagation
- » K_{Ic}, J_{Ic}
- » Component strength and durability
- » Dynamic characterization damping
- » Tension
- » Compression
- » Bending
- » Shear

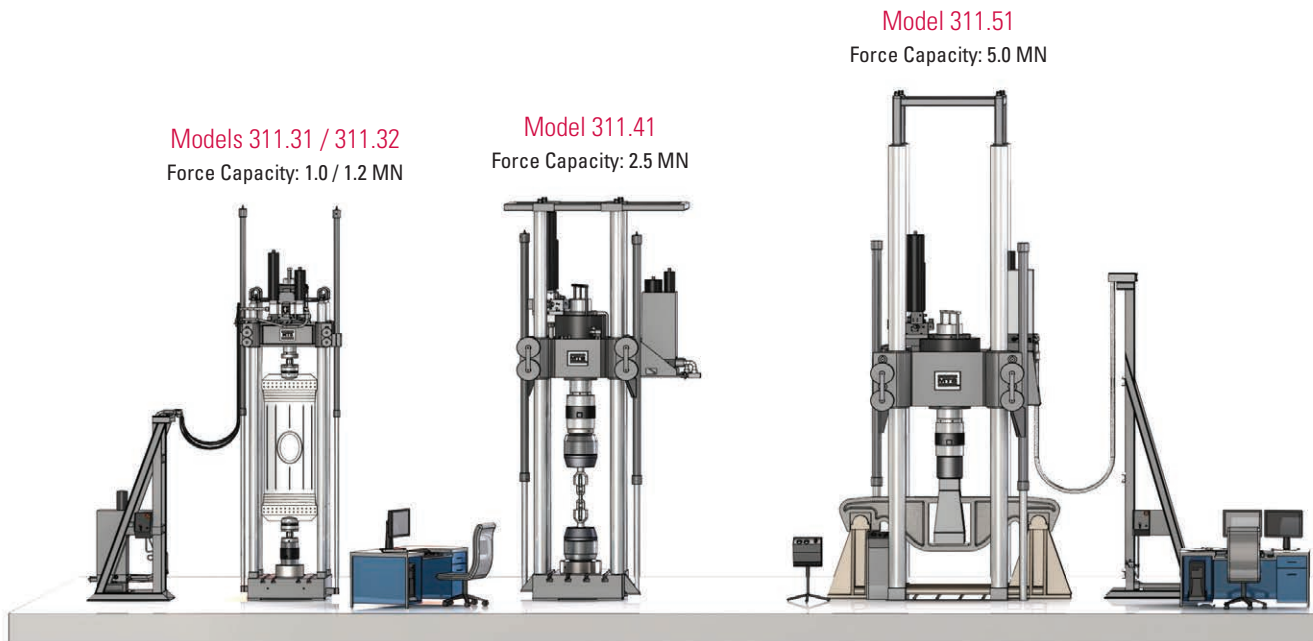

A Full Spectrum of High-force Testing Possibilities*

Industry	Aerospace	Metals	Rail
Test Type	Fatigue test of composite panel	Static test of steel chain	Fatigue evaluation of bogey
Accessories	Model 647 Hydraulic Grips with custom fixture	Model 641 Hydraulic Grips	Custom Fixture
Force Transducer	Base-mounted	Actuator-mounted	Actuator-mounted
Base	Standard T-slot	Standard T-slot	Floor-level T-slot
Optional Features	Hose stand with integrated hydraulic service manifold and crosshead lift/lock controls	Crosshead-mounted hydraulic service manifold, free-standing crosshead lift/lock controls, and free-standing hydraulic grip supply	Crosshead-mounted hydraulic service manifold, and hose stand with integrated lift/lock controls

Note: The examples in this chart demonstrate the wide breadth of testing that can be addressed by the MTS high-force system family; it is not intended to provide specific test application or system configuration guidance.

Model 311.91
Force Capacity: 30.0 MN

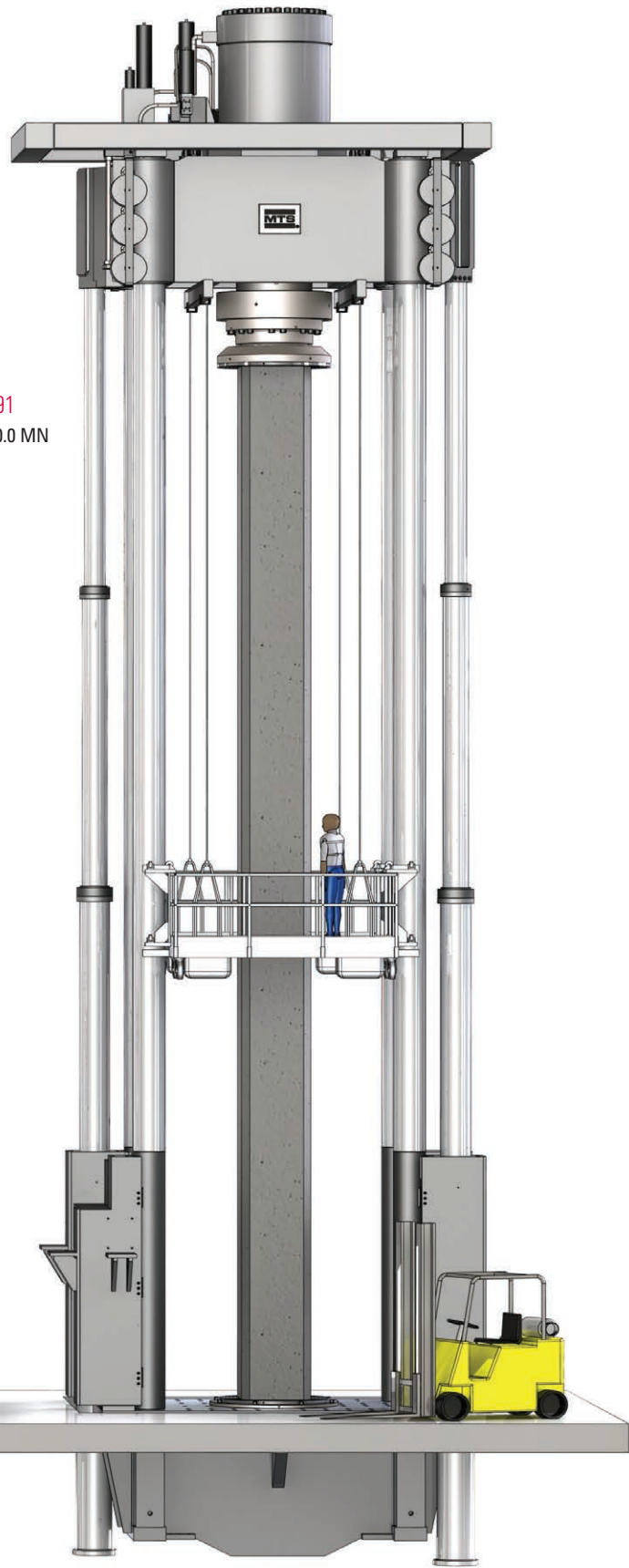

Model 311.71
Force Capacity: 10.0 MN



Construction Material

Bend test of structural steel beam
4-point bend fixture

- Actuator-mounted
- Extended integrated reaction base
- Hose stand with integrated lift/lock controls, crosshead mounted HSM

Civil Engineering

Compression test of reinforced concrete column
Compression platens

- Actuator-mounted
- Integrated strong floor
- Powered personnel lift

A full range of hydraulic performance options

A selection of hydraulic performance packages allows you to configure a standard Model 311 load frame to meet your specific static or dynamic high-force testing requirements. Critical components include MTS servovalves and performance-matched SilentFlo™ Hydraulic Power Units (HPUs). MTS servovalves are available with flows of 112, 340, or 680 lpm rated at 70 bar pressure drop. Servovalve pilot pressure ensures tight control of the system actuator at startup. Available in a variety of capacities to accommodate required test loads and speed, SilentFlo HPUs deliver the cleanest and quietest hydraulic power available. They can be deployed directly in the lab, eliminating the cost for special pump housing facilities and reducing supply line cost and space requirements.



SilentFlo HPU

Optional hydraulic system features include:

- » High-frequency response, high-flow capacity 3-stage servovalves
- » Additional accumulation for enhanced performance
- » Modular hose stand capable of supporting both standard and high-capacity servovalve options
- » Floor-standing, hose stand-mounted, or crosshead-mounted hydraulic service manifolds (HSM)



Actuator Manifold



Hose Stand



Hydraulic Service Manifold

State-of-the-art Digital Controls

Stable, precise system control, which is critical for conducting high-force fatigue testing, is provided by a state-of-the-art FlexTest® controller. FlexTest digital controllers equip users with all the tools needed to define and automate virtually any material, component or structural test. Versatile FlexTest controllers provide high speeds and channel densities to keep pace with evolving test demands, and share common hardware boards and user interface tools to simplify test standardization and optimization across test laboratories. FlexTest controllers support the full offering of MTS test application software, including MTS TestSuite™ Multipurpose software, TestWorks® software, and MultiPurpose TestWare® (MPT™) software.



FlexTest Controller

Versatile, Easy-to-use MTS Application Software

MTS high-force systems leverage the power of MTS application software to provide full-featured test definition, intuitive displays and user-friendly operation, and powerful results analysis and reporting capabilities.

Foremost among these materials testing packages is MTS TestSuite software. Designed with extensive user input, the MTS TestSuite platform serves as the foundation for a growing set of easy-to-use material test modules. It features a visually intuitive common interface to streamline and simplify the development of calculations and test workflows. For example, you can “drag and drop” test sequences into the test editor and view a graphic depiction of the workflow as you develop it. Currently available applications include MTS TestSuite Multipurpose Software, which features test modules for performing low-cycle fatigue, high-cycle fatigue, advanced low-cycle fatigue, fatigue crack growth, and fracture toughness applications.

The MTS TestSuite platform also features a host of innovative tools designed to extend testing power and increase productivity:

- » Virtual Specimen allows you to accurately simulate specimen behavior before breaking any real test articles
- » Point-by-point Monitoring allows users to perform calculations and make decisions on every data point rather than making decisions once per cycle

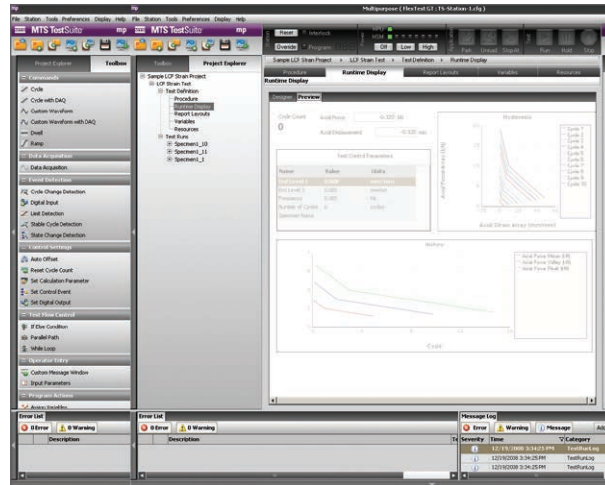

- » Multichannel is used to create multi-axial loading conditions with enforced phase relationships between multiple channels

Additionally, the optional MTS TestSuite Analyzer provides the ability to glean new insight from post-test data for both fatigue and fracture applications.

MTS high-force systems can also employ other MTS application software packages such as TestWorks software and MultiPurpose TestWare software.

Full Complement of High-force Grips, Fixtures and Platens

To support a full spectrum of high-force loading applications, MTS complements its high-force system offering with a selection of precision, side-loading hydraulic wedge grips for tensile and fatigue testing (available with an optional hydraulic grip supply), as well as platens for compression testing and

fixtures for bend testing. MTS high-force systems are also available with a standard T-slot base, which can serve as an interface for supporting a wide variety of custom fixtures. MTS can also work with you to develop custom fixtures to meet unique testing needs.



Hydraulic Grips

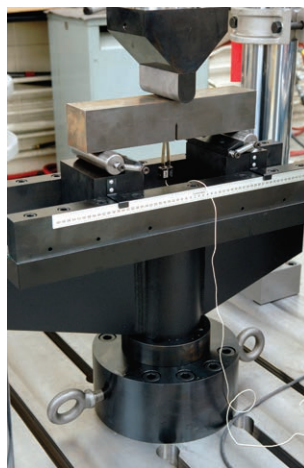

Bend Fixture

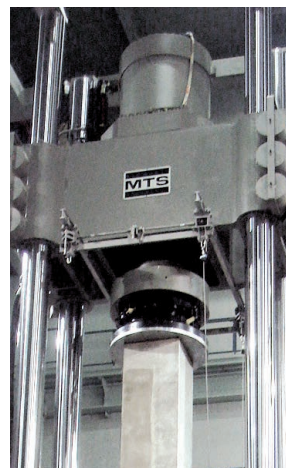

Compression Platens

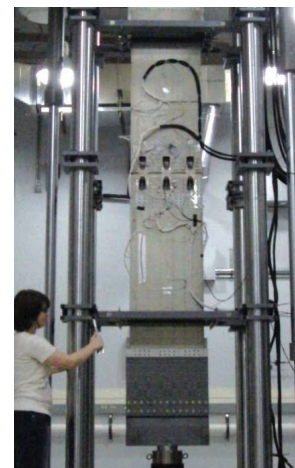

Custom Fixtures

Photo courtesy of MERC

Unparalleled MTS Service & Support

MTS high-force test systems are backed by the global MTS Service & Support organization. This highly experienced team offers lifecycle management services for all your test systems and is committed to maximizing the uptime and operational efficiency of your test system. With the expertise to support your test equipment from pre-installation to decommission and at every point in between, MTS has the service solutions to meet your needs for test schedule predictability, data integrity, system performance optimization and budget management.

- » **ONSITE SERVICES:** MTS field service engineers have a worldwide reputation for applications expertise and will respond to your request for support or repair quickly and efficiently.
- » **ENGINEERING SERVICES:** MTS offers a complete set of professional engineering services, including systems engineering, test consulting and facilities design services.
- » **TRAINING:** MTS training programs are designed to improve operator efficiency and optimize system performance. Expertly led and completely customizable, these courses provide hands-on learning to ensure that your staff is thoroughly familiar with your test systems and know how to operate them safely and effectively.



Load Frame Alignment



Load Frame Calibration

- » **CALIBRATION & ALIGNMENT:** All test labs must calibrate their testing equipment to help ensure data accuracy. MTS provides top-quality, accredited calibration services, which can be performed onsite or in our factory metrology labs. We also offer load frame alignment services to minimize data variance.
- » **MAINTENANCE & MONITORING:** Based on decades of service experience, MTS has developed a set of well-defined routine maintenance offerings tailored for specific systems and components, to help extend equipment life and provide you with confidence in your equipment operation.
- » **UPGRADE SOLUTIONS:** As technology improves, an upgrade is often the most economical way of expanding your lab capabilities and extending the life of existing test equipment. MTS offers upgrades and replacements for all areas of your test system, including mechanical components, controllers and software.

High-force System Performance Curves

The following pages contain a series of charts that outline performance characteristics for standard systems across the MTS high-force family – Models 311.31, 311.32, 311.41 and 311.51.

Each chart graphically demonstrates the influence specimen mass has on the performance of the configuration by plotting Specimen Displacement (mm) vs. Frequency (Hz) for four loading conditions. The configuration's usable performance range for a particular load is depicted as the area below its respective curve.

Within each individual chart, factors such as actuator size, actuator stroke and servovalve size are held constant. To demonstrate how system performance is dependent on these factors, each model's performance is plotted on multiple charts that vary by actuator and servovalve configuration.

While the charts assume that available hydraulic power is not a limiting factor, it is important to note:

- » Increasing the actuator size will provide more force, which in turn requires more hydraulic power to run the test at the same speed.
- » Increases in performance are attained by increasing servovalve size, which also requires more hydraulic power.

These charts represent a sampling of the available MTS high-force family performance curves – contact your MTS applications engineer to review the full array of performance curves for each standard MTS high-force system.

9

Configuration: Model 311.31 with 113 lpm (30 gpm)*

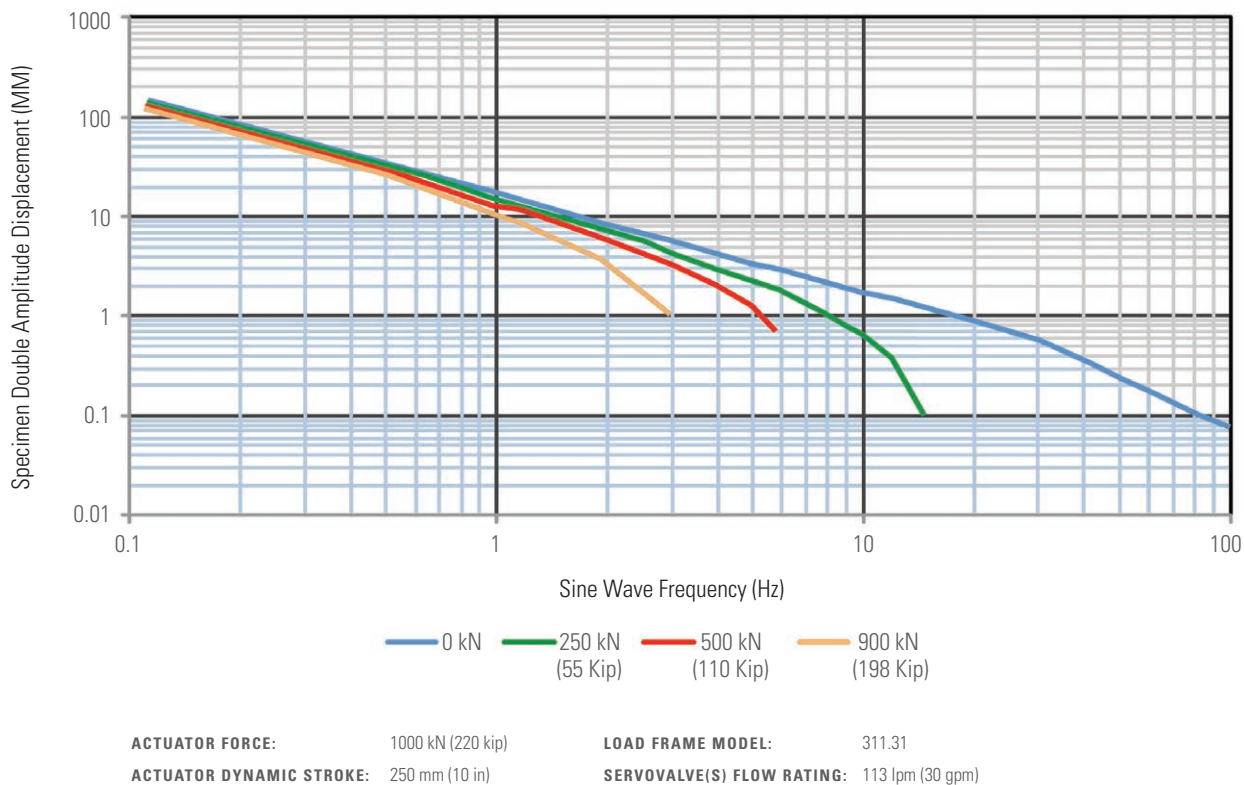

* Systems profiled feature hydraulic power units, accumulation, pressure and return hoses selected to match the load frame system configurations. Hydraulic power supplies support 21 MPa (3000 psi) pressure and have been selected to minimally limit the performance provided by other components. The performance curves depicted represent a mathematical prediction of system performance using appropriately sized hydraulic wedge grips holding a linear spring specimen. The use of small servovalves will slow the speed of actuation to the point where full end to end stroke will not be attained even when operating at low frequencies. Your MTS sales representative can discuss these and other available performance options.

Configuration: Model 311.31 with 340 lpm (90 gpm)*

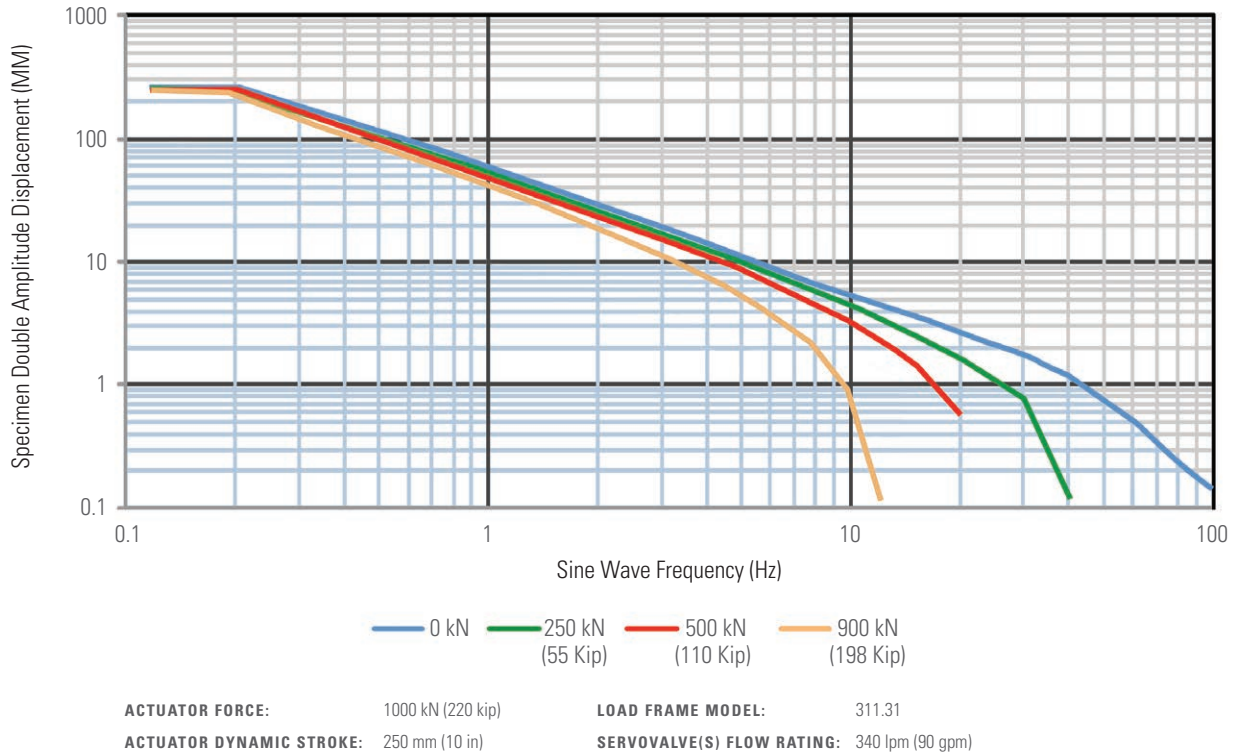

Configuration: Model 311.32 with 113 lpm (30 gpm)*

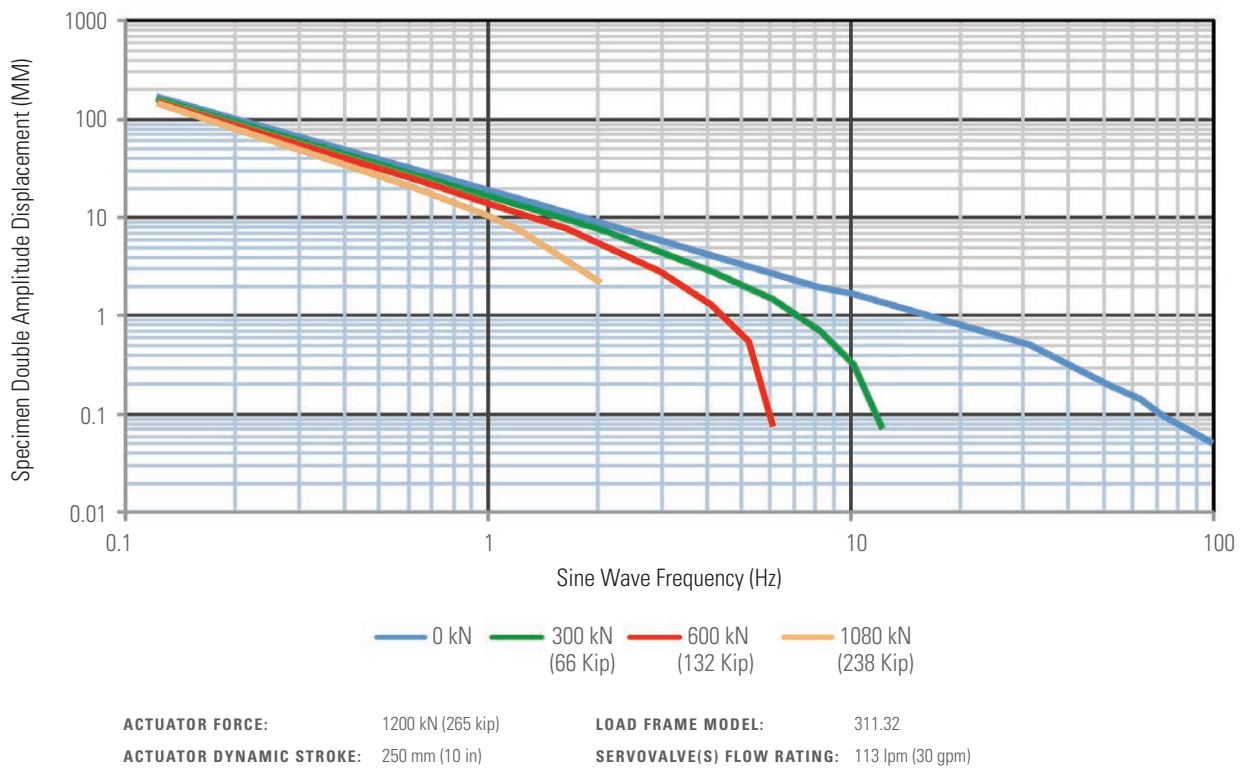

* Systems profiled feature hydraulic power units, accumulation, pressure and return hoses selected to match the load frame system configurations. Hydraulic power supplies support 21 MPa (3000 psi) pressure and have been selected to minimally limit the performance provided by other components. The performance curves depicted represent a mathematical prediction of system performance using appropriately sized hydraulic wedge grips holding a linear spring specimen. The use of small servovalves will slow the speed of actuation to the point where full end to end stroke will not be attained even when operating at low frequencies. Your MTS sales representative can discuss these and other available performance options.

Configuration: Model 311.32 with 340 lpm (90 gpm)*

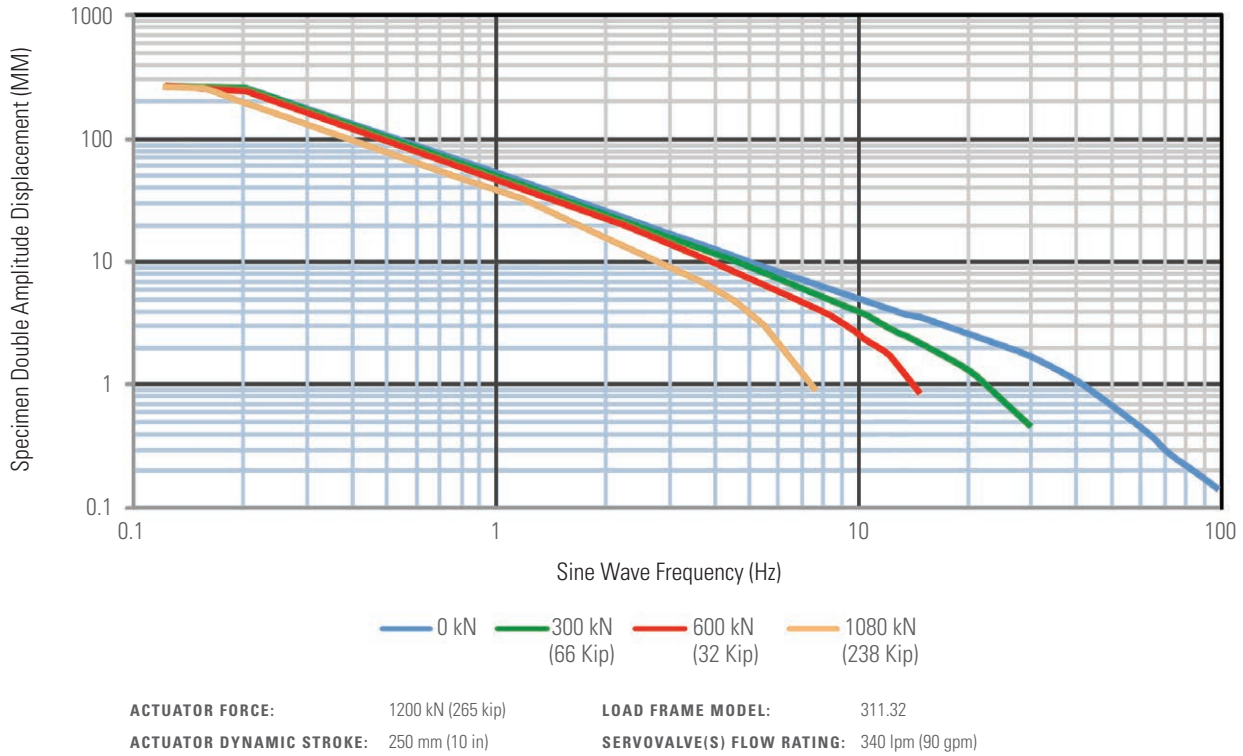

11

Configuration: Model 311.41 with 113 lpm (30 gpm)*

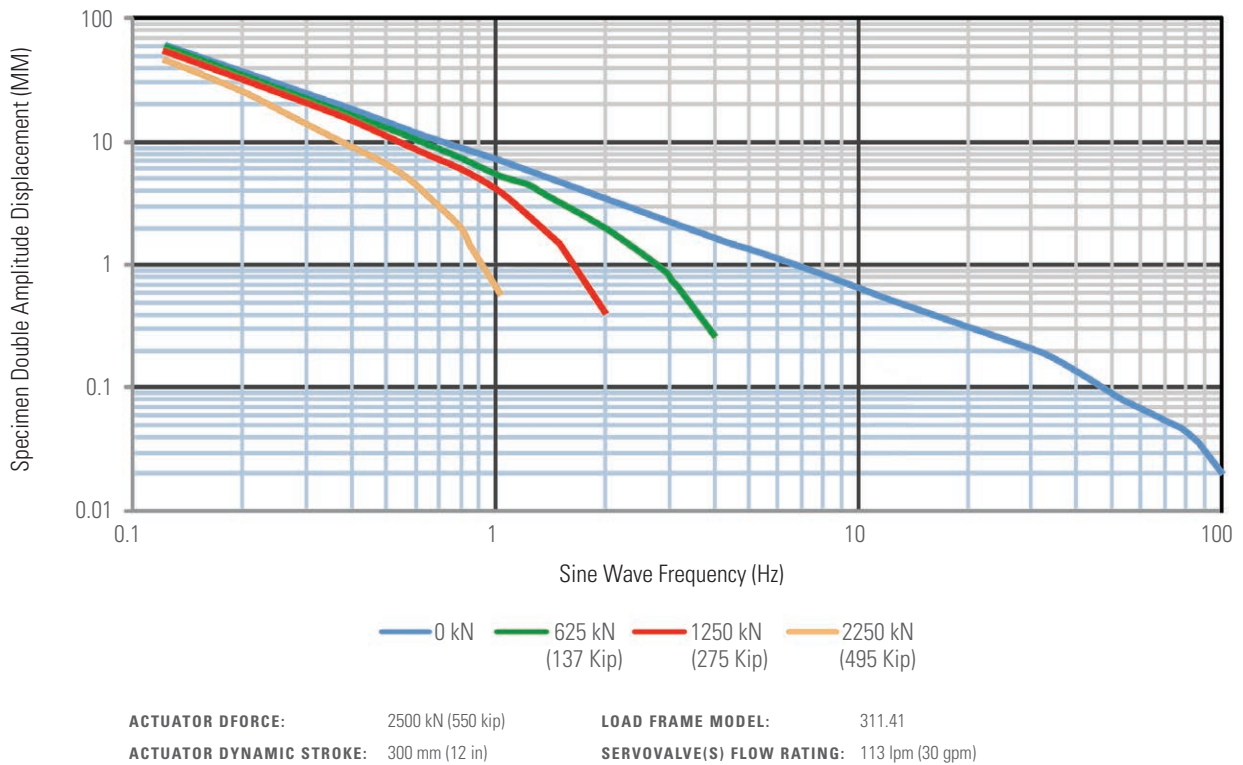

Configuration: Model 311.41 with 340 lpm (90 gpm)*

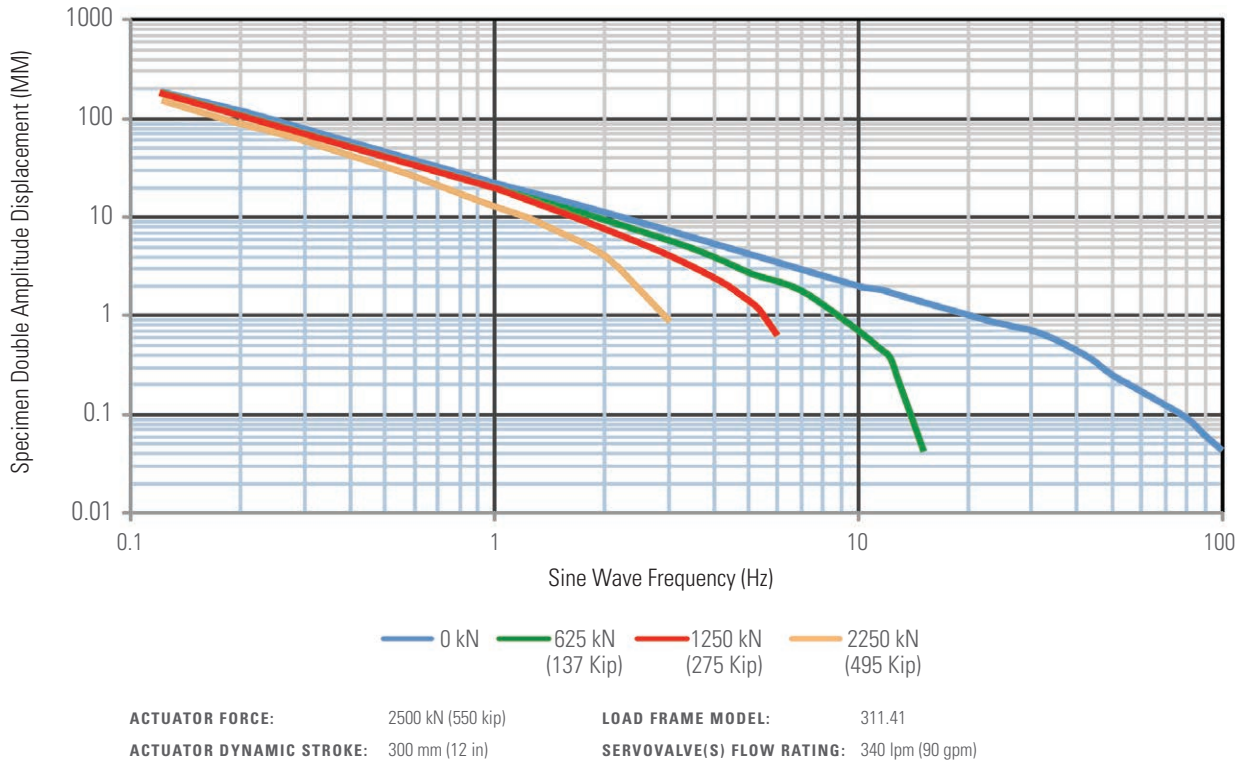

Configuration: Model 311.41 with 680 lpm (180 gpm)*

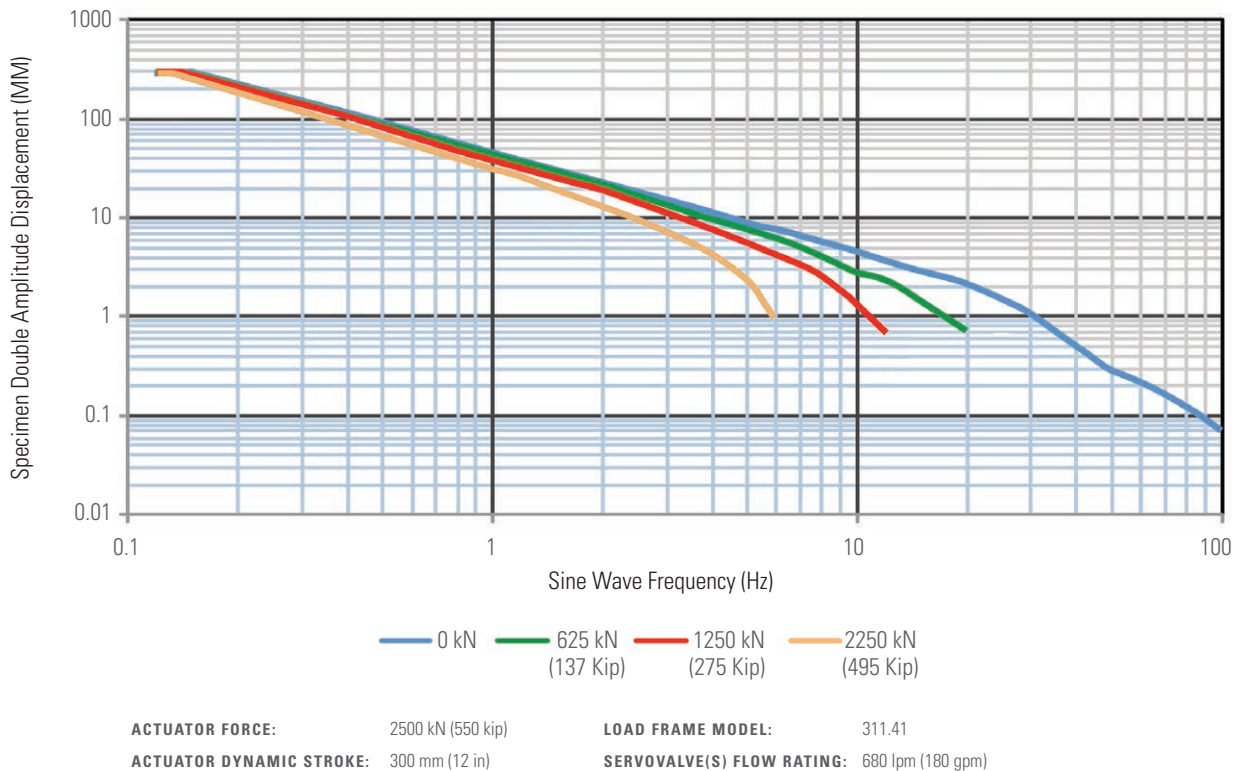

* Systems profiled feature hydraulic power units, accumulation, pressure and return hoses selected to match the load frame system configurations. Hydraulic power supplies support 21 MPa (3000 psi) pressure and have been selected to minimally limit the performance provided by other components. The performance curves depicted represent a mathematical prediction of system performance using appropriately sized hydraulic wedge grips holding a linear spring specimen. The use of small servovalves will slow the speed of actuation to the point where full end to end stroke will not be attained even when operating at low frequencies. Your MTS sales representative can discuss these and other available performance options.

Configuration: Model 311.51 with 340 lpm (90 gpm)*

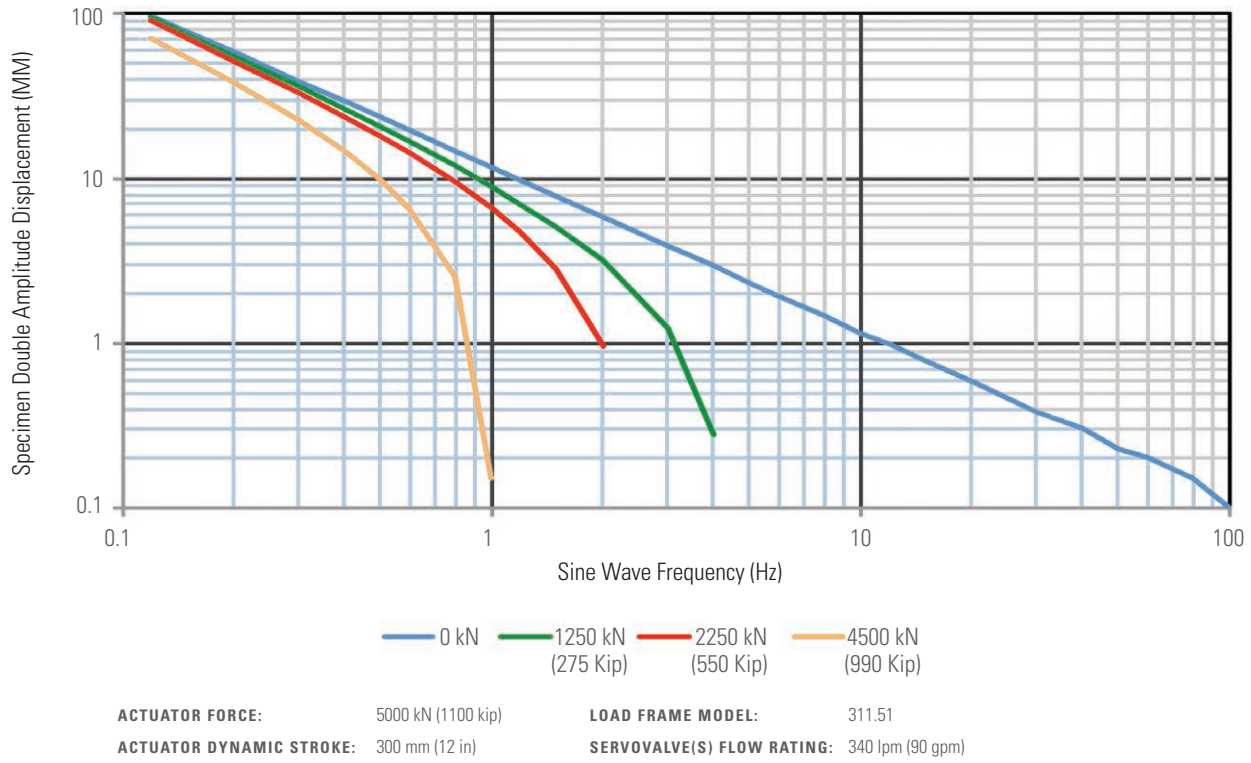

13

Configuration: Model 311.51 with 680 lpm (180 gpm)*

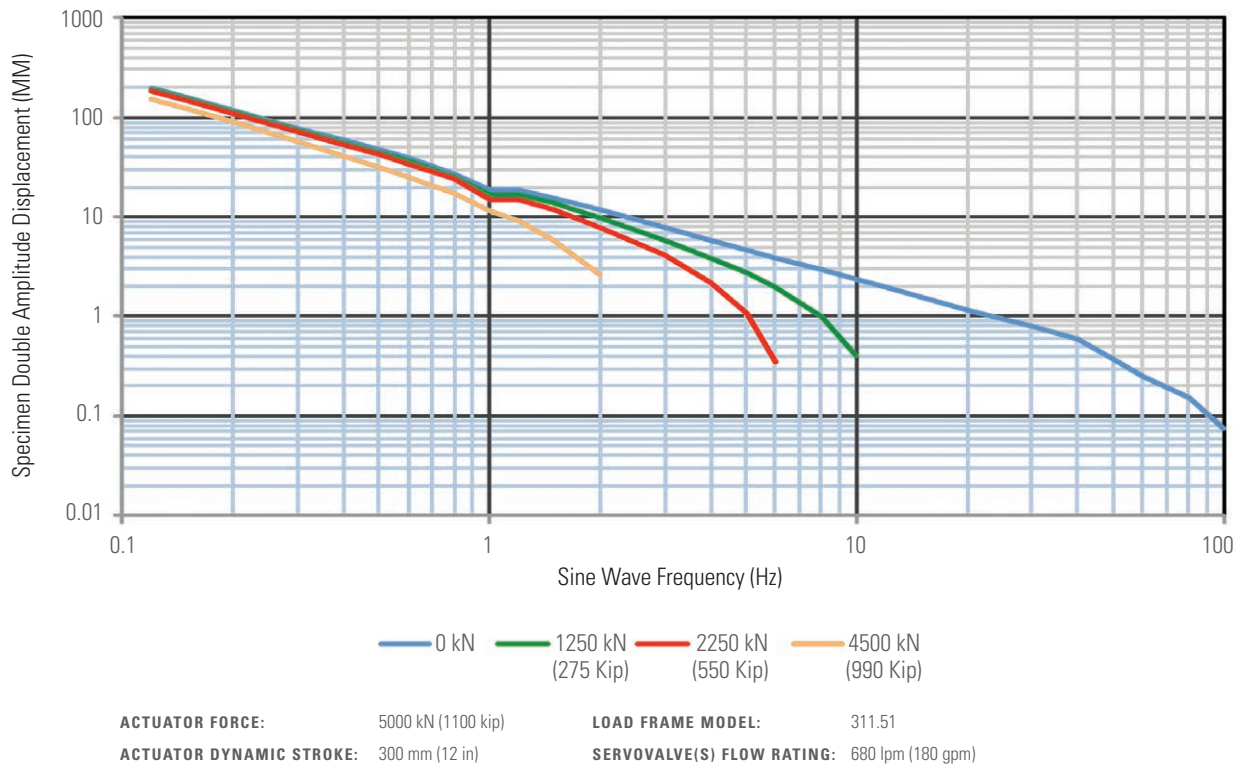

Model 311 High Force Load Frames Specifications

Load Frame Specifications	Diagram Detail	Units	Model							
			Standard				Custom			
			311.31	311.32	311.41	311.51	311.61	311.71	311.81	311.91
Dynamic Force Ratings		kN (kip)	1000 (220)	1200 (265)	2500 (550)	5000 (1100)	7500 (1650)	10 000 (2200)	20 000 (4400)	30 000 (6600)
Standard Dynamic Strokes		mm (in)	150, 250 (6, 10)	150, 250 (6, 10)	150, 300 (6, 12)	300 (12)				
Column Diameter	A	mm (in)	101.6 (4.00)	101.6 (4.00)	152.4 (6.00)	203.2 (8.00)				
Column Spacing	B	mm (in)	711.2 (28.0)	711.2 (28.0)	762.0 (30.0)	1016.0 (40.0)				
Column Spacing	C	mm (in)	406.4 (16.0)	406.4 (16.0)	508.0 (20.0)	812.8 (32.0)				
Load Frame Height (min-max)	D	mm (in)	2946-5486 (116-216)	2946-5486 (116-216)	<i>Note₃</i> <i>Note₃</i>	4470-8534 (176-336)				
Specimen and Grip Spacing (min-max)	E ₁	mm (in)	254-2794 (10-110)	254-2794 (10-110)	<i>Note₂</i> <i>Note₂</i>	450-4500 (17.8-177)				
Base Width	F	mm (in)	914.4 (36.0)	914.4 (36.0)	1066.8 (42.0)	1422.4 (56.0)				
Base Width (including lifts)	G	mm (in)	1219 (48.0)	1219 (48.0)	1492.5 (58.8)	1903 (75.0)				
Base Depth	H	mm (in)	1016.0 (40.0)	1016.0 (40.0)	1168.4 (46.0)	1397 (55.0)				
Base Height From Floor	J	mm (in)	280.9 (11.06)	280.9 (11.06)	332 (13.06)	450 (17.8)				
Hose Stand Spacing (max)	K	mm (in)	921 (36.3)	921 (36.3)	2479 (97.7)	2479 (97.7)				
Hose Stand Width	L	mm (in)	991 (39.0)	991 (39.0)	991 (39.0)	991 (39.0)				
Hose Stand Depth	M	mm (in)	688 (27.1)	688 (27.1)	688 (27.1)	688 (27.1)				
Hose Stand Height	N	mm (in)	2426 (95.5)	2426 (95.5)	2819 (111.0)	3200 (126.0)				
Approximate Crosshead Weight		kg (lb)	1225 (2700)	1225 (2700)	2903 (6400)	7938 (17,500)				
Approximate Total Weight		kg (lb)	4100 (9100)	4100 (9100)	9525 (21,000)	21,500 (47,500)				
System Stiffness_s		N/m lbf/in	1.6 X 10 ⁹ 9.3 X 10 ⁶	1.6 X 10 ⁹ 9.3 X 10 ⁶	3.1 X 10 ⁹ 17.4 X 10 ⁶	3.9 X 10 ⁹ 22.6 X 10 ⁶				

Custom load frame dimensions vary according to customers' specific application requirements. Consult an MTS Application Engineer for more information.

Notes:

1. Model 311.31 & 311.32 with actuator retracted, 311.41 & 311.51 with actuator at mid-stroke
2. Model 311.41 150 mm stroke is 400 – 3000 mm (15.75 – 118.1 in), 311.41 300 mm stroke is 400 – 3385 (13.31 – 133.3 in)
3. Model 311.41 150 mm stroke is 3554 – 6154 (140.0 – 242.3 in), 311.41 300 mm stroke is 3720 – 6768 (146.5 – 266.5 in)
4. Stiffness calculated at a crosshead height of 2 meters (78.7 inch) above the base.

System Dimensions

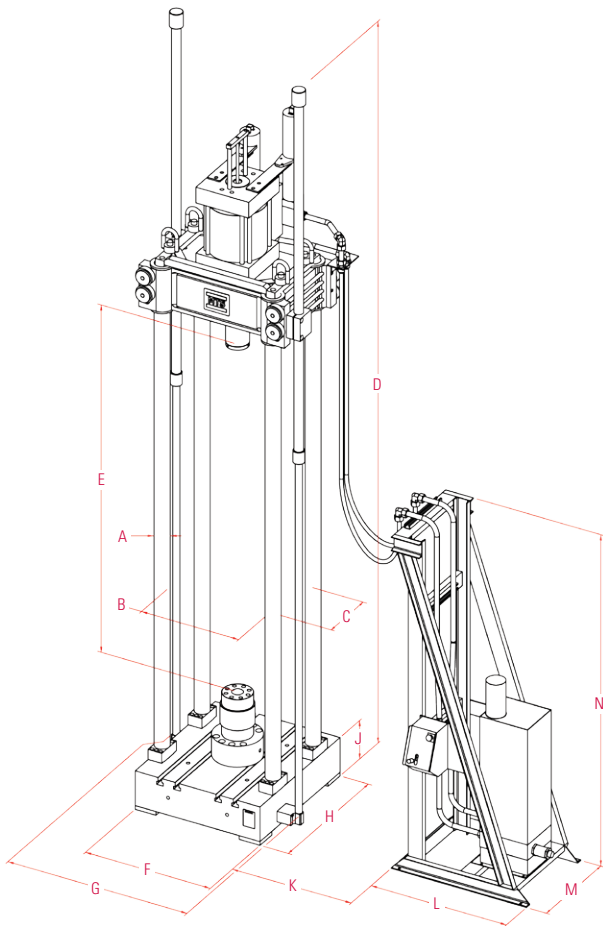

System Geography

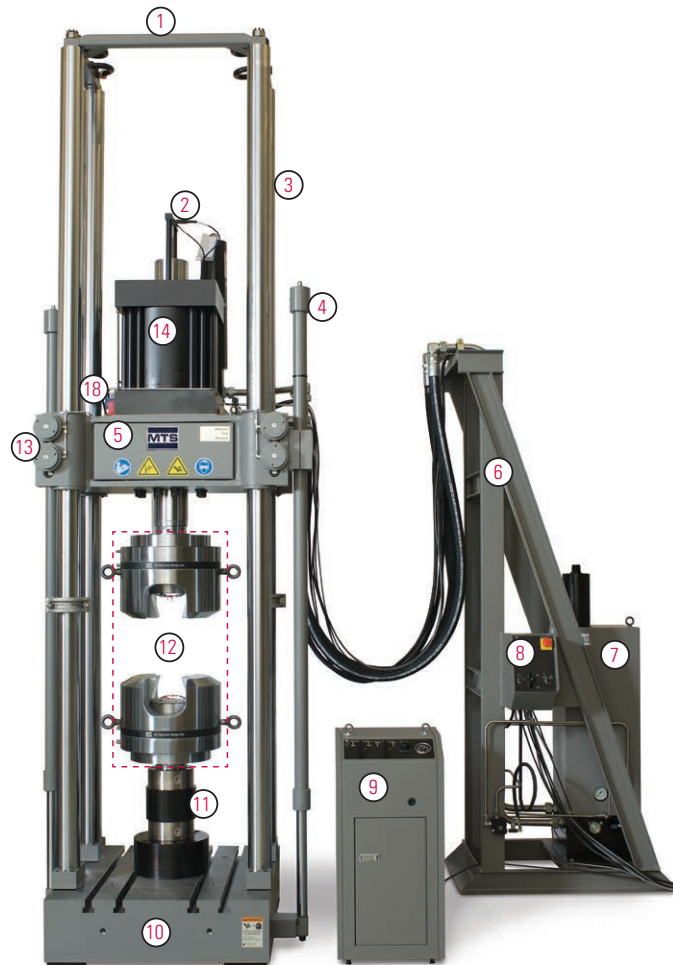

15

System Geography

- ① Optional Tie Bar
- ② High-accuracy Linear Variable Differential Transducer (LVDT)
- ③ Precision-machined Columns
- ④ Optional Hydraulic Crosshead Positioning Cylinders
- ⑤ High-Stiffness Crosshead
 - Integrated Actuator
 - Integrated Hydraulic Manifold
- ⑥ Optional Hose Stand
- ⑦ Hydraulic Service Manifold (HSM)
 - Optional hose stand-mounted
 - Optional crosshead-mounted (shown)
 - Optional floor-standing
- ⑧ Crosshead Lift/Lock Controls
 - Optional hose stand-mounted (shown)
 - Optional floor-standing
- ⑨ Optional Hydraulic Grip Supply
- ⑩ Load Frame Base Options
 - Standard T-Slot (shown)
 - Integrated Strong Floor
 - Extended Integrated Reaction Base
- ⑪ Precision Force Transducer
 - Base-mounted (shown)
 - Actuator-mounted
- ⑫ Optional High-force Accessories
 - Compression Platens
 - Hydraulic Wedge Grips (shown)
 - Bend Fixtures
 - Custom Fixtures
- ⑬ Crosshead Clamping Mechanism
- ⑭ High-performance MTS Actuator
 - Crosshead-mounted
 - High-stiffness
 - Double-ended
 - Dynamically rated
- ⑮ Close-coupled Accumulators
- ⑯ MTS Servo Valve
 - Available with flows of 112, 340, or 680 lpm rated at 1000 psi pressure drop
- ⑰ Actuator Velocity Limiting Circuit
- ⑱ Piston Rod Holding (Anti-drift) Device

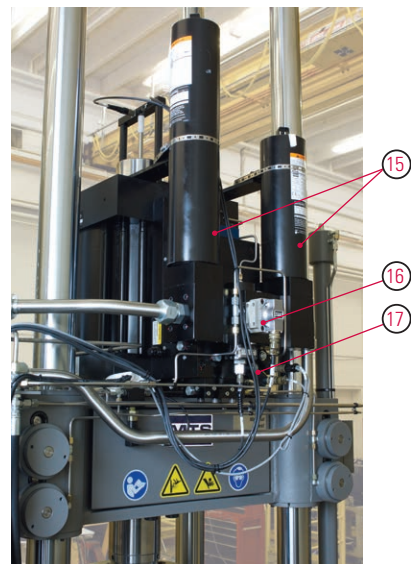

Regional Business Centers

THE AMERICAS

MTS Systems Corporation

14000 Technology Drive
Eden Prairie, MN 55344-2290
USA
Telephone: 952-937-4000
Toll Free: 800-328-2255
Fax: 952-937-4515
E-mail: info@mts.com
Internet: www.mts.com

EUROPE

MTS Systems France

BAT EXA 16
16/18 rue Eugène Dupuis
94046 Créteil Cedex
France
Telephone: +33-(0)1-58 43 90 00
Fax: +33-(0)1-58 43 90 01
E-mail: contact.france@mts.com

MTS Systems GmbH

Hohentwielsteig 3
14163 Berlin
Germany
Telephone: +49-(0)30 81002-0
Fax: +49-(0)30 81002-100
E-mail: euroinfo@mts.com

MTS Systems S.R.L. a socio unico

Strada Pianezza 289
10151 Torino
Italy
Telephone: +39-(0)11 45175 11 sel. pass.
Fax: +39-(0)11 45175 00-01
E-mail: mtstorino@mts.com

MTS Systems Norden AB

Datavägen 37
SE-436 32 Askim
Sweden
Telephone: +46-(0)31-68 69 99
Fax: +46-(0)31-68 69 80
E-mail: norden@mts.com

MTS Systems Ltd. UK

Unit 9, Cirencester Office Park
Tetbury Road
Cirencester
Gloucestershire
GL7 6JJ
United Kingdom
Telephone: +44-(0)1285-648800
Fax: +44-(0)1285-658052
E-mail: mtsksales@mts.com

ASIA/PACIFIC

MTS Japan Ltd.

ArcaCentral Bldg. 8F
1-2-1 Kinshi, Sumida-ku
Tokyo 130-0013
Japan
Telephone: 81-3-6658-0901
Fax: 81-3-6658-0904
E-mail: mtsj-info@mts.com

MTS Korea, Inc.

4th F., ATEC Tower, 289,
Pankyo-ro, Bundang-gu
Seongnam-si
Gyeonggi-do 463-400,
Korea
Telephone: 82-31-728-1600
Fax: 82-31-728-1699
E-mail: mtsk-info@mts.com

MTS China Hechuan Office

Room 703 Building #B,
Venture International Park,
No. 2679 Hechuan Road,
Minhang District,
Shanghai 201103,
P.R.China
Telephone: +86-21-5427 1122
Fax: +86-21-6495 6330
E-mail: info@mtschina.com



MTS Systems Corporation

14000 Technology Drive
Eden Prairie, MN 55344-2290 USA

ISO 9001 Certified QMS
<http://www.mts.com>

MTS, FlexTest, TestWare, and TestWorks are registered trademarks and MPT, MTS TestSuite, and SilentFlo are trademarks of MTS Systems Corporation in the United States. These trademarks may be protected in other countries. RTM No. 211177.

©2014 MTS Systems Corporation
100-228-148c HighForceServohydraulicSystem Printed in U.S.A.10/14